

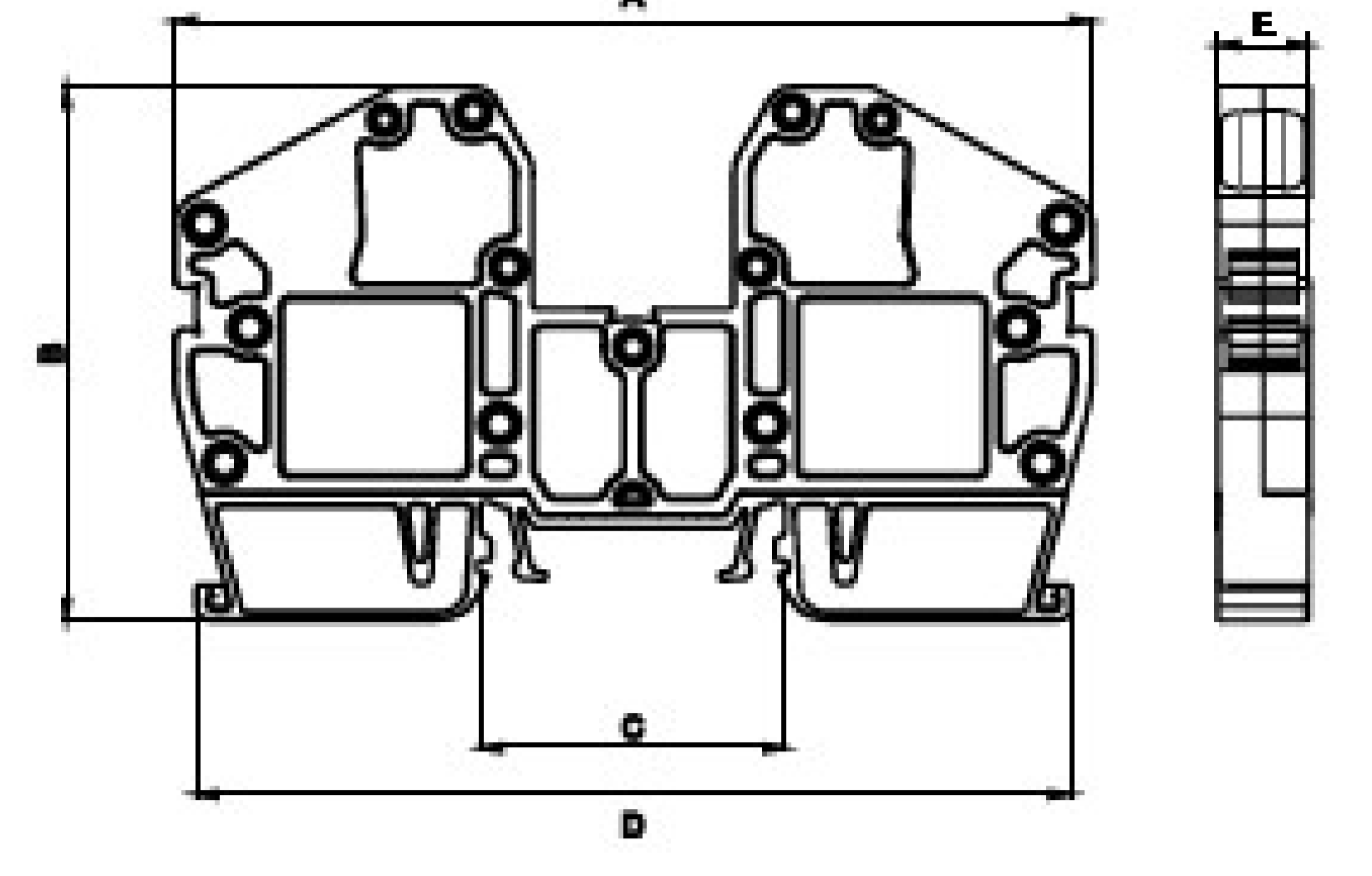

OPK 16mm² PUSH-IN RAIL TERMINAL BLOCK

Product code:
Product code: 1542



<https://onka.com.tr/opk-16mm2-push-in-rail-terminal-block>

Dimensions

Dimensions (mm)	
A	103
B	60
C	34.5
D	98
E	10.7

Materials

Body	PA6.6
Bridge	Copper
Orange Button	PA6.6
Spring	Stainless Steel
Temperature	-40°C,+140°C
Cable Strip L.	22mm
Data	TSE/CE
Voltage	750V
Current	76A
Section	16mm ²

Color

	V2	V0	
Colour	Order No	Order No	Pcs.
Grey	1542	0962	30
Cream	1543	0963	30
Black	1544	0964	30
Blue	1545	0965	30
Brown	1546	0966	30
Red	1547	0967	30
Yellow	1548	0968	30
Green	1549	0969	30

Cross

Order No	Section	Pcs.
1955	16/2	10
1956	16/3	10
1957	16/4	10
1958	16/10	10

Stopper

Stopper-1202,1212,1222

Sticker

Group Sticker-1232

Marking

Marking-9770/4442/9540
