

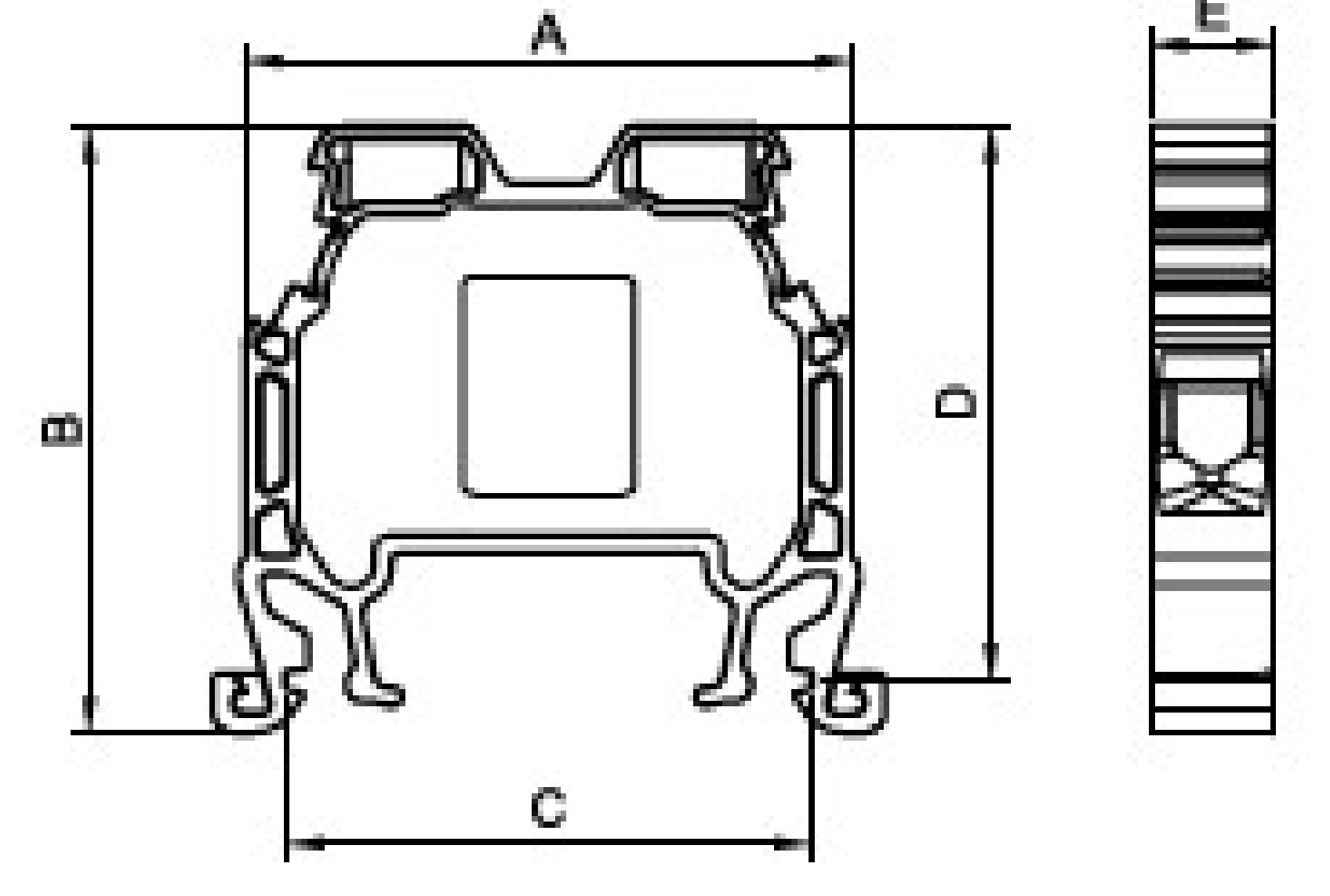

MRK 6mm² SCREW CONNECTION RAIL TERMINAL BLOCK

Product code:
Product code: 1032



<https://onka.com.tr/mrk-6mm2-screw-connection-rail-terminal-block>

Dimensions

Dimensions (mm)	
A	40
B	40
C	34.5
D	36.5
E	8.2

Materials

Body	PA6.6	
Bridge	Copper	
Contact	CK45 Steel	
Screw	Steel	
Temperature	-40°C,+140°C	
Cable Strip L.	12mm	
Torque	0,8Nm	
Data	TSE/CE	UL
Voltage	750V	300V
Current	41A	41A
Section	6mm ²	8AWG
Norm	EN-60947-7-1	UL1059

Color

	V2	V0	
Colour	Order No	Order No	Pcs.
Grey	1032	0782	100
Cream	1033	0783	100
Black	1034	0784	100
Blue	1035	0785	100
Brown	1036	0786	100
Red	1037	0787	100
Yellow	1038	0788	100
Green	1039	0789	100

Cross

Order No	Section	Pcs.
1930	6/2	100
1931	6/3	50
1932	6/4	50
1933	6/10	15
1934	6/20	10

Stopper

Stopper-1202,1212,1222

Sticker

Group Sticker-1232

Marking

Marking-9770/2630/4442/9540/7301
